

ORTHOSHOPS s.r.l.
Punto Vendita :
Ortopedia Josetto Mori srl
Via Manzoni 25
08100 Nuoro

ATS-AZIENDA TUTELA SALUTE
PG/2021/123804 del 08/04/2021 ore 16,39
Mitt.: ORTHOSHOPS SRL
Ass.: SC Servizio Giuridico Amministrat...
Class.: 1.2.11.



Spett. ASSL Nuoro

OGGETTO: Preventivo di spesa per barella doccia

Come da vostra richiesta di seguito il nostro miglior preventivo per :

- N° 1 Barella doccia idraulica in acciaio verniciato NEFTI
Portata max 180 kg
€. 2297.00 + iva
- N° 1 Barella doccia elettrica in acciaio verniciato NEFTI
Portata max 200 kg
€. 2637.18 + iva
- N° 1 Barella doccia elettrica in acciaio verniciato bariatrica NEFTI
Portata mx 325 kg
€. 5596.99 + iva
- N° 1 Barella doccia idraulica in acciaio verniciato pediatrica NEFTI Kids
Portata max 180 kg
€. 2475.75 + iva

In allegato schede tecniche dei vari modelli

In attesa di un vostro cortese riscontro porgiamo

 **ORTHOSHOPS**
PROGETTIAMO AUTONOMIA
Distinti Saluti
Sede legale: Via A.B. Nobel, 80 - 42124 Reggio Emilia (RE)
Punto Vendita: Via Manzoni, 25 - 08100 Nuoro (NU)
0784 33143 - mori@progettiamoautonomia.it
C.S. € 50.000 i.v. - P.IVA e iscr. Reg. Imp. di R.E. 02698780356
www.orthoshops.it - info@orthoshops.it

Barella doccia elettrica in acciaio verniciato

NEFTI^{BIG}

Bariatrica

MADE IN ITALY
100%

Cod. **B1200**



Motorizzazione

T MOTION

Telo imbottito in PVC rinforzato con poliestere privo di ftalati sanificabile



BARIATRICO
325 KG

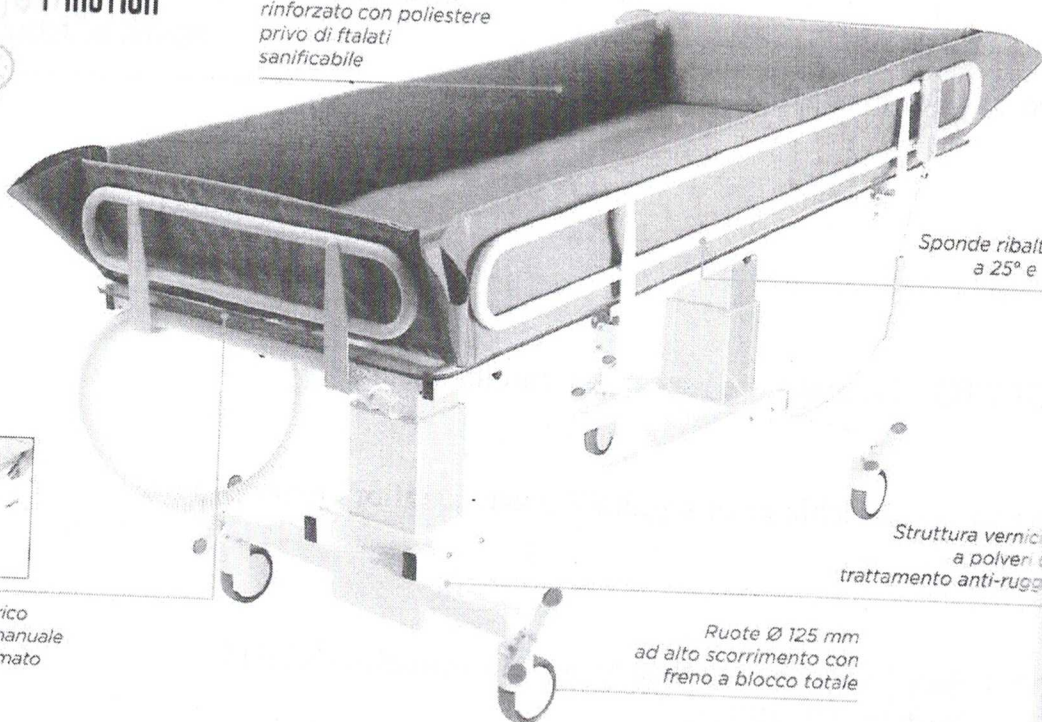

Sponde ribaltabili a 25° e 180°

Struttura verniciata a polveri con trattamento anti-ruggine

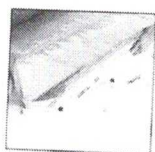

Piletta di scarico a pressione manuale in ottone cromato

Ruote Ø 125 mm ad alto scorrimento con freno a blocco totale

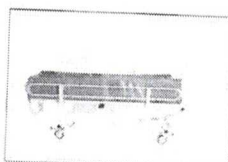

Movimento in altezza da 59 a 93 cm
Inclinazione da 0° a 5°

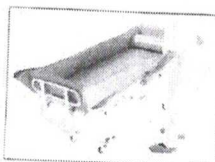

Sponde inclinabili in due posizioni 25° e 180°

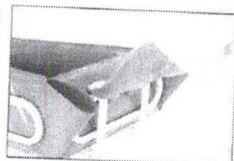

Ottima manovrabilità tramite le sponde lato testa/piedi

Accessori optional

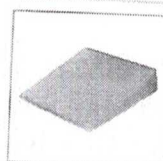

Cod. **BIA110**
Cuscino a cuneo cm 55x55x14 / 2 h, inclinazione 15°

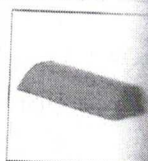

Cod. **BIA100**
Cuscino semicilindrico cm 55x15x7 h

Caratteristiche tecniche

RIFERIMENTI

DPCM 12.01.2017 08.12.05.015

RDM 1775994

DIMENSIONE E PESO

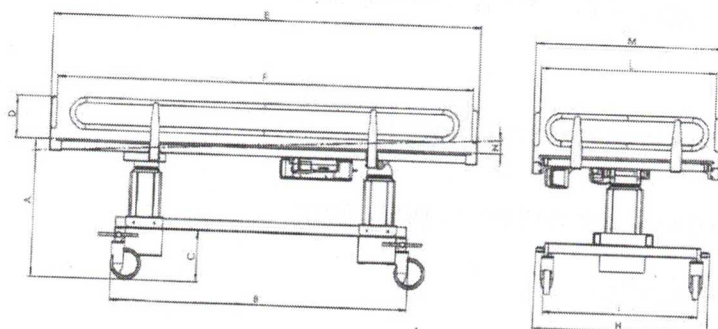

A	B	C	D	E	F	H	I	L	M	N
65-94 cm	143,5 cm	23 cm	20 cm	205 cm	200 cm	84,5 cm	75 cm	86 cm	91 cm	0°-7°

Barella doccia idraulica in acciaio verniciato **NEFTL**

Portata max 180 kg

MADE IN ITALY
100%

Cod. **B1100**

Telo imbottito in PVC
rinforzato con poliesteri
privo di ftalati
sanificabile

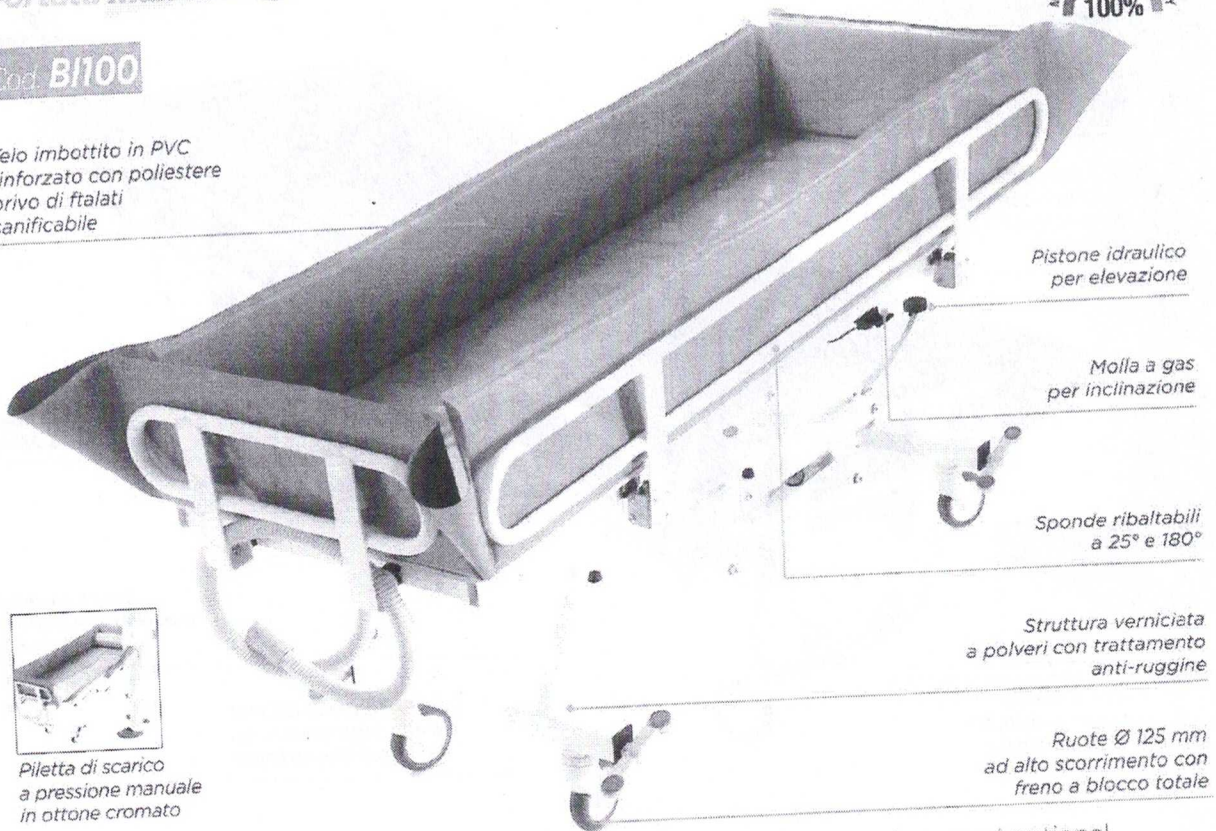

Piletta di scarico a pressione manuale in ottone cromato

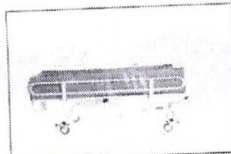

Movimento in altezza da 59 a 93 cm
Inclinazione da 0° a 5°

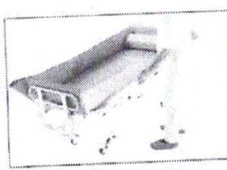

Sponde inclinabili in due posizioni 25° e 180°



Ottima manovrabilità tramite le sponde lato testa/piedi

Accessori optional

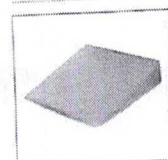

Cod. **BIA110**
Cuscino a cuneo cm 55x55x14 / 2 h, inclinazione 15°



Cod. **BIA100**
Cuscino semicilindrico cm 55x15x7 h

Caratteristiche tecniche

RIFERIMENTI

DPCM 12.01.2017 09.12.03.015

RDM 1573234

DIMENSIONE E PESO

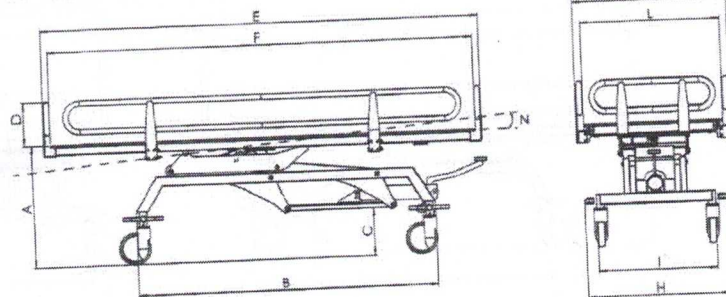

A	B	C	D	E	F	H	I	L	M	N	
59-93 cm	141 cm	23 cm	20 cm	206 cm	200 cm	67 cm	56 cm	66 cm	73 cm	0°-5°	180 Kg

Doccia elettrica in acciaio verniciato

NEFTI

Capacità max 200 kg

MADE IN ITALY
100%

80° T MOTION

Tela imbottita in PVC
rinforzato con poliestere
cassa di telati
lavabile

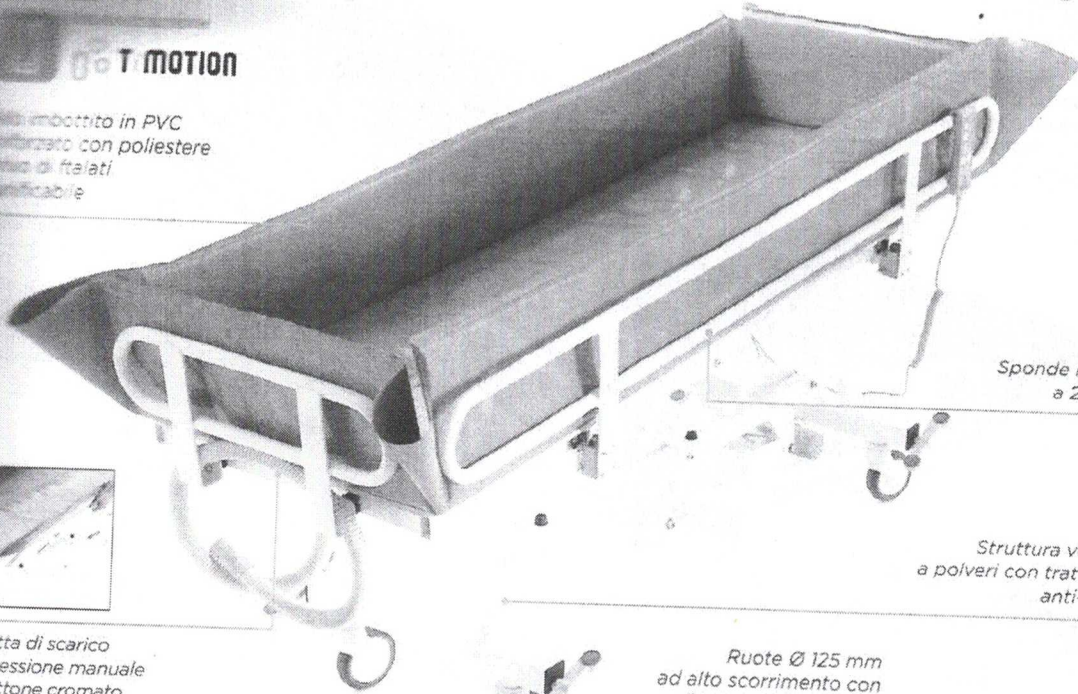

Sponde ribaltabili
a 25° e 180°

Struttura verniciata
a polveri con trattamento
anti-ruggine

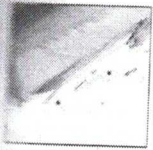

Pietta di scarico
a pressione manuale
in ottone cromato



Ruote Ø 125 mm
ad alto scorrimento con
freno a blocco totale

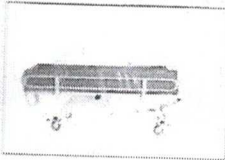

Movimento in altezza
da 59 a 99 cm
Inclinazione da 0° a 5°

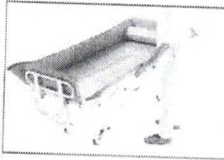

Sponde inclinabili
in due posizioni 25° e 180°

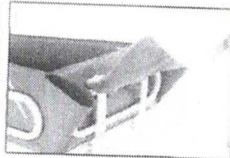

Ottima manovrabilità
tramite le sponde lato testa/piedi

Accessori optional

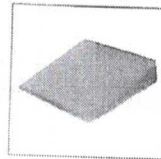

Cod. **BIAT10**
Cuscino a cuneo
cm 55x55x14 / 2 h,
inclinazione 15°



Cod. **BIAT00**
Cuscino
semicilindrico
cm 55x15x7 h

Caratteristiche tecniche

RIFERIMENTI

DPCM 12.01.2017 09.12.03.015

RDM 1573240

DIMENSIONE E PESO

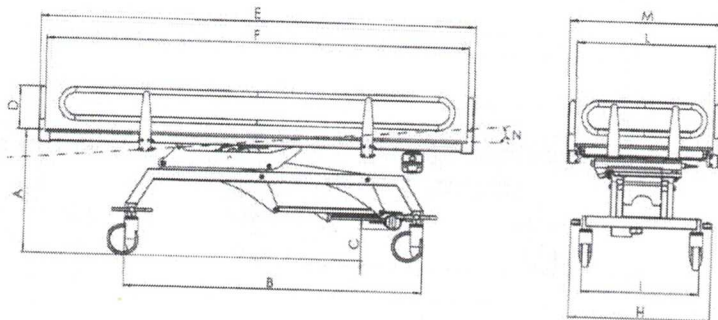

A	B	C	D	E	F	H	I	L	M	N	
59-99 cm	141 cm	16 cm	20 cm	206 cm	200 cm	67 cm	56 cm	66 cm	73 cm	0°-5°	200 Kg

Barella doccia idraulica in acciaio verniciato

NEFTI STABIL

Idraulica - Portata max 180 kg

MADE IN ITALY
100%

NEFTI kids

Interno imbottito in PVC
rivestito con poliestere
cuscini di filato
ventilabile

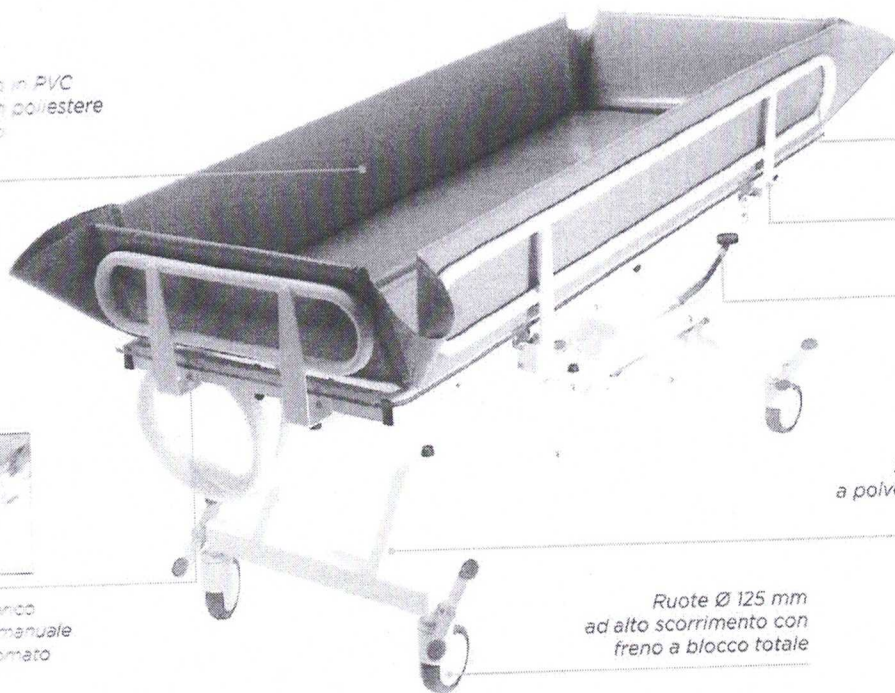

Sponde ribaltabili
a 25° e 180°

Molla a gas
per inclinazione

Pistone idraulico
per elevazione

Struttura verniciata
a polveri con trattamento
anti-ruggine

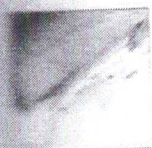

Manetta di scando
regolazione manuale
a frizione promata

Ruote Ø 125 mm
ad alto scorrimento con
freno a blocco totale

Accessori optional

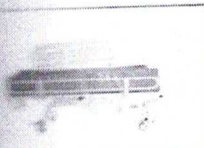

Movimento in altezza
da 59 a 93 cm
Inclinazione da 0° a 5°

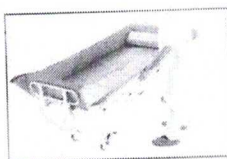

Sponde inclinabili
in due posizioni 25° e 180°

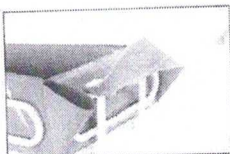

Ortoma manovrabilità
tramite le sponde lato testa/piedi

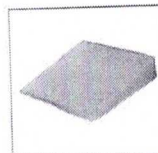

Cod. **BIA110**
Cuscino a cuneo
cm 55x55x14 / 2 h,
inclinazione 15°



Cod. **BIA100**
Cuscino
semicilindrico
cm 55x15x7 h

Caratteristiche tecniche

REFERIMENTI

SPDK 12.01.2017 09.12.03.015

IGN 1775992

DIMENSIONE E PESO

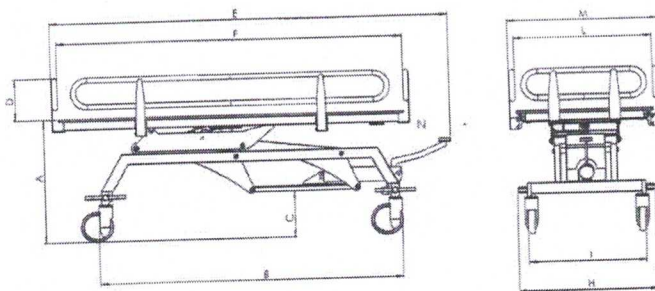

A	B	C	D	E	F	H	I	L	M	N	
65-91 cm	143,5 cm	19,5 cm	20 cm	170,5 cm	165,5 cm	65,5 cm	56 cm	67 cm	72 cm	0°-5°	180 Kg

